

*Pure Freude  
an Wasser*

**GROHE**  
WAVES



YOUR  
**KITCHEN**

2017

GROHE BRAND	4
KITCHEN FEATURES	11
GROHE WATER SYSTEMS	33
GROHE PREMIUM LIFESTYLE COLLECTIONS	81
GROHE PERFORMANCE LINES	137
GROHE SOAP DISPENSERS	176



**OPENWATERHEATER**

The perfect flow in combination with open water heaters.



**EASYEXCHANGE**

The aerator is easy to install and de-install using just a coin.



**EASYDOCK**

Guaranteed easy retraction and smooth docking for your pull-out spray head, every time.



**STOPVALVE**

Includes a dishwasher shut-off valve on the faucet body.



**REALSTEEL**

Made of solid stainless steel, a robust material with anti-bacterial properties.



**SPEEDCLEAN**

Remove limescale with a single wipe.



**PREWINDOW**

To open the window, just lift up the faucet and lay it flat on the surface.



**EASYTOUCH**

Just touch the faucet at any point with your wrist, elbow or just your fingertip to turn the faucet ON and OFF.



**FORWARD ROTATING LEVER**

Forward rotating lever prevents the lever hitting the backsplash.



**COMFORTHEIGHT**

Height of the spout allows easy filling of large pots.



**FOOTCONTROL**

Just touch the bottom side of the cabinet with a gentle tap of your foot to turn the faucet ON and OFF.



**ZERO (Lead+Nickel Free)**

No contact of water with lead and nickel due to isolated inner water ways.



**ENHANCED WATER**

Superior-quality water directly from the kitchen faucet – saving time, money and the environment.



**PULL-OUT MOUSSEUR**

Increases the operating radius of your faucet.



**GROHFLEXX**

With flexible, hygienic GrohFlexx kitchen santoprene hose.



**PULL-OUT MOUSSEUR SPRAY**

Increases operating radius of the faucet and offers different sprays.



**PROFESSIONAL-SPRAY**

Features a 360° spring arm and easy switching between the spray and mousseur.



**EASYDOCK M**

Integrated magnet for seamless docking of the spray head.



**CHILDLOCK**

Integrated safety mechanism prevents unintentional opening by young children.



**PULL-OUT DUAL SPRAY**

Increases operating radius of the faucet and offers easy switching between mousseur and the spray.



**AQUAGUIDE**

Variable spout end for adjustment of water flow.



**TITANIUM INSIDE**

All boilers in our GROHE Red collection are made from titanium.



**SWIVELSTOP**

Limited turn angle prevents flooding.



**GROHE SILKMOVE**

Smoothest handling for effortless precision and ultimate comfort for a lifetime.



**GROHE COOLTOUCH**

No scalding on hot surfaces thanks to 100% GROHE CoolTouch.



**GROHE ECOJOY**

Save precious resources and enjoy 100% water comfort.



**GROHE SILKMOVE ES**

The intelligent combination of energy saving and effortless water control.



**GROHE STARLIGHT**

Made-to-last surfaces ranging from precious matt to shiny like a diamond.

# HANDS ON **FEATURES**

Accommodating your every wish and desire, GROHE water systems and kitchen faucets include user-centric features and ingenious details that make all the difference. More choice, more comfort and more flexibility; which is why our products are such a pleasure to use.



Welcome to the smartest product portfolio in the industry,  
where kitchen taps, water systems and consumer-oriented  
features combine with outstanding design. Enjoy the  
ultimate GROHE kitchen experience.



Dear customers,

The kitchen is the heart of the home. It's where the family gathers, friends connect and experiences are shared. At GROHE we use our unique craftsmanship to create smart technology to effortlessly deliver water to your kitchen to cook, clean, drink and enjoy. We are dedicated to creating elegant and intelligent products that combine design, quality, technology and sustainability. With our most complete kitchen portfolio ever, we are driven by our goal to be at the heart of your home.

A perfect example of our ethos is our GROHE water systems. Our award-winning design reflects our heritage as skilled and innovative craftsmen. At the slightest touch of a button or gentle twist of the tap, GROHE Red and Blue systems provide you with the purest filtered water, either hot or cold. Delivering fresh water into your glass or cup eliminates the need for bottled water or kettles, creating a more sustainable way to enjoy water in your life.

We know that creating fantastic food requires technology which is reliable and functional: technology with unique features and intelligent design reflecting your personal taste. This understanding has allowed us to develop GROHE's market-leading Premium Lifestyle Collections,

with clever and beautiful features like our GROHE Easytouch or GROHE Foot Control products, helping to liberate your hands in the kitchen. Or our distinctive Essence Professional Colour designs, all created to encourage your culinary creativity, another addition to our comprehensive kitchen portfolio.

A passion for taste is central to what you create in the kitchen, at GROHE we aim to complement this with our passion for delivering the very best craftsmanship and engineering expertise in every one of our products. We credit this approach for the success of our Performance Lines, which deliver multiple design combinations, versatile height and installation options to allow you to create kitchens that are safer, easier and more enjoyable to use.

This unique combination of expert craftsmanship and forward-thinking innovation means we can deliver the products you need to build kitchens that are practical, reliable and beautiful: the hallmark of GROHE.

A handwritten signature in black ink, appearing to read 'M. Rauterkus', is centered on a light gray rectangular background.

Yours, Michael Rauterkus  
Chief Executive Officer  
Grohe AG

# PURE FREUDE AN WASSER.

Life-giving, universal, joyful – water itself is the source of inspiration for the whole of our distinctive product portfolio.

Each of these products is always based on our four core values: Quality, Technology, Design and Sustainability. Balancing these in everything we do, allows us to deliver unrivalled water enjoyment to our customers.









## QUALITY

### **GERMAN PERFECTIONISM INSPIRES ULTIMATE CUSTOMER CONFIDENCE.**

We strive for an excellence that goes way beyond the surface of our products. In fact, from design to production and customer service we aim for nothing less than perfection at every stage. Our history of great German engineering, rigorous internal tests and numerous external certification processes are what gives our customers complete confidence in a name they can trust.



## TECHNOLOGY

### **MASTERING WATER THROUGH TECHNOLOGY.**

In our relentless search for technological innovation we work to integrate the latest digital advances, creating smart solutions that enhance our customers' enjoyment of water. Our in-house experts harness the power of water to enhance the experience of our customers every day – the moment of truth, for our products and brand.



## DESIGN

### **SIGNATURE ELEMENTS STYLED TO PERFECTION.**

An empathetic and intuitive design language offers us the opportunity to create products that feel as if they were designed just for you. This unique GROHE DNA that is both ergonomic and visually distinctive has earned us numerous design awards: world class references are testimony to our world-wide recognition.



## SUSTAINABILITY

### **ENSURING WATER ENJOYMENT FOR GENERATIONS TO COME.**

Water is as essential as the air that we breathe, one more reason why we are so passionate about it. To be able to offer "Pure Freude an Wasser", not just to today's consumer but for generations to come, we offer sustainable product solutions like GROHE Blue, GROHE EcoJoy and GROHE SilkMove ES, and we demonstrate through our Sustainability Report and Sustainability accolades that we have made a serious corporate commitment to protecting the planet.



Winner 2017









GROHE BRAND	4
<b>› KITCHEN FEATURES</b>	<b>11</b>
FOOTCONTROL	12
EASYTOUCH	14
TYPES OF SPOUTS	16
POWERFUL SPRAYS	20
SUPERSTEEL	26
PREWINDOW	28
OPENWATERHEATER	29
ZERO (LEAD+NICKEL FREE)	30
STOPVALVE	31
GROHE WATER SYSTEMS	33
GROHE PREMIUM LIFESTYLE COLLECTIONS	81
GROHE PERFORMANCE LINES	137
GROHE SOAP DISPENSERS	176

# KITCHEN FEATURES

Accommodating your every wish and desire, GROHE water systems and kitchen faucets include user-centric features and ingenious details that make all the difference. More choice, more comfort and more flexibility: which is why our products are such a pleasure to use.



**30 311 000**  
Electronic Sink Mixer  
L-spout  
with pull-out dual spray



**FOOTCONTROL**

Just touch the bottom side of the cabinet with a gentle tap of your foot to turn the faucet ON and OFF.







# GROHE FOOTCONTROL

For kitchens where time is of the essence and convenience is a must, why not go hands-free? GROHE's new FootControl faucets can be turned On and Off with a gentle tap of your foot on the base unit, leaving your hands free and your faucet spotless at all times. Three of our most popular faucets come with this innovative FootControl technology, or you can retro-fit the feature to any GROHE pull-out kitchen faucet. To say goodbye to germs, mess and hassle, simply tap your feet!

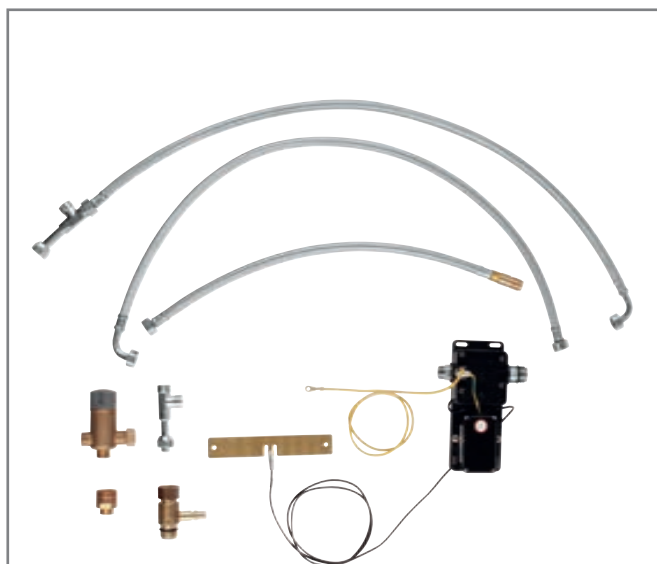

## 30 309 000

Retro-Fit set

for upgrading any GROHE pull-out kitchen faucet with **FootControl** technology.

Available on following lines:

K7, Zedra, Minta, K4, Essence, Parkfield, Europlus, Eurodisc Cosmopolitan, Eurodisc, Concetto, Eurostyle Cosmopolitan, Eurosmart Cosmopolitan, Eurosmart

Except for low pressure variants and GROHE EasyTouch faucets.

# GROHE **EASYTOUCH**

Kitchens are hands-on places, where multi-tasking is a must. Why not make life easier for yourself with a GROHE touch-activated faucet? We've developed a choice of two innovative solutions that let you control the flow of water without using your hands, making your kitchen more hygienic, convenient and instinctive to use. GROHE faucets can be activated with a simple touch of the wrist or elbow. Leave your hands free and keep your faucet sparkling clean. Change the way you control your kitchen with just a single touch.

The kitchen is the heart of your life at home – and let's face it, sometimes life gets messy. With GROHE's innovative EasyTouch faucets sticky fingers won't slow you down and cross-contamination is a thing of the past. Hidden GROHE technology lets you start and stop the flow of water with a single tap of your arm, wrist or the back of your hand, anywhere on the spout. No more greasy fingerprints or struggling to turn a lever with your elbow.





**EASYTOUCH**

Just touch the faucet at any point with your wrist, elbow or just your fingertip to turn the faucet ON and OFF.

**31 360 001**  
Electronic Sink Mixer  
L-spout  
with pull-out dual spray







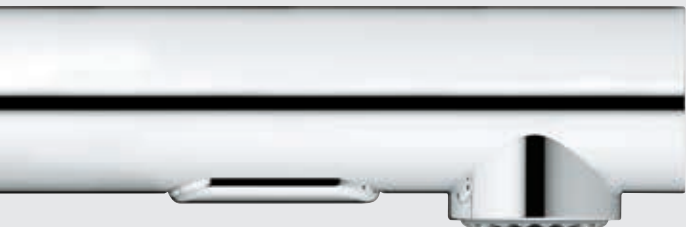

## TYPES OF SPOUTS

Our range of spout options let you combine comfort and convenience with great design flexibility. Our spouts come in a variety of heights, from a compact low spout for small spaces to a high spout perfect for filling pots, as well as in a choice of U, C or L-shape to perfectly suit your style. Need even more flexibility? Our spouts that swivel or feature pull-down spray heads offer extra reach, power and performance for busy kitchens.

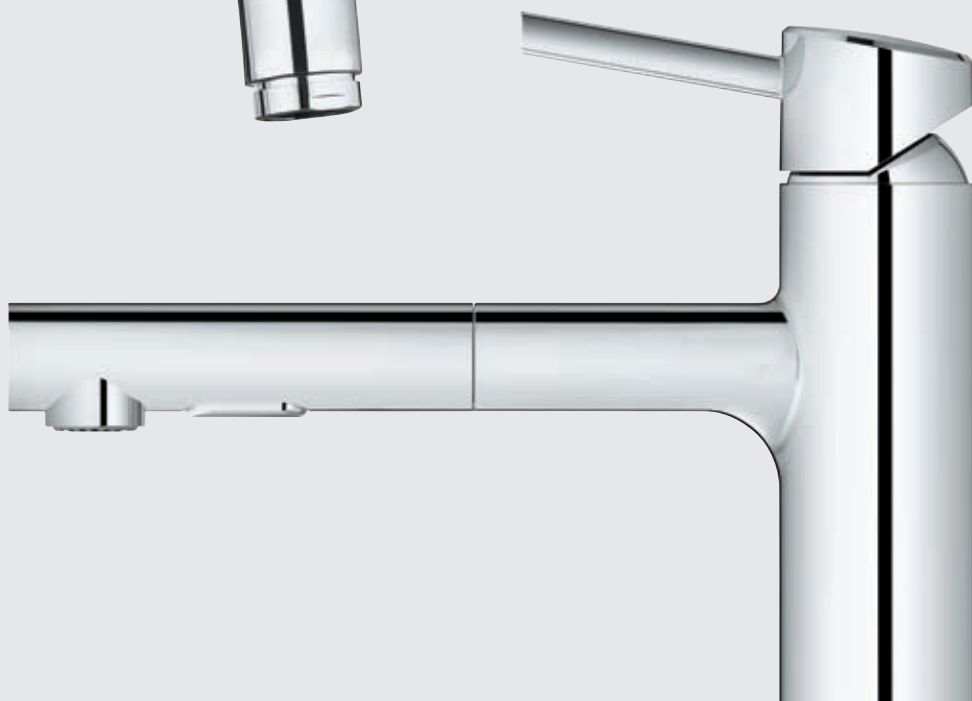











# POWERFUL SPRAY FUNCTIONS

Get some power behind your daily tasks with GROHE's range of professional and pull-out sprays. Enjoy an increased operating radius for maximum convenience, and on many models you can also switch between two spray functions for even greater flexibility. The GROHE EasyDock function with glideflex hose ensures the spray docks smoothly back into position, and on some professional spray models GROHE EasyDock M uses a magnet to guide the spray head back into place effortlessly, every time. When your work is done enjoy the easy-clean advantage of GROHE's SpeedClean feature - available on all pull-out sprays with two spray functions - that lets you clean limescale from the head with a simple sweep of your finger.



## **PROFESSIONAL SPRAY**

Features a 360° spring arm and easy switching between the spray and mousseur.



**31 395 DC0**  
Professional sink mixer







**PULL-OUT DUAL SPRAY**

Increases operating radius of the faucet and offers easy switching between mousseur and the spray.



**30 270 000**  
Sink mixer high spout  
with pull-out dual spray



**GROHFLEXX**

With flexible, hygienic GrohFlexx kitchen santoprene hose



**EASYDOCK M**

Integrated magnet for seamless docking of the spray head.







**PULL-OUT MOUSSEUR  
SPRAY**

Increases operating radius  
of the faucet and offers  
different sprays.

**31 482 002**

Sink mixer high spout  
with pull-out mousseur spray





**EASYDOCK**

Guarantees easy retraction and smooth docking for your pull-out spray head, every time.

**32 663 001**  
Sink mixer high spout  
with pull-out mousseur



**PULL-OUT MOUSSEUR**

Increases the operating radius of your faucet.



# GROHE **SUPERSTEEL**

## **SUPER LOOKS – SUPER RESISTANCE**

To fulfil its purpose, a kitchen fitting needs to be resistant. GROHE's SuperSteel surface more than fits this bill. In fact, the innovative PVD coating is ten times more scratch-resistant than chromium. The silk-matt stainless steel surface not only looks unbelievably good, but also demonstrates its resistance in daily use. Fingerprints on the surface? Not here. And nowhere on the surface for microbes and bacteria to lurk either, which greatly reduces the microbial count. So the surface of the fitting stays hygienically clean, day after day.



# GROHE PVD

## UNRIVALED HARD AND SCRATCH RESISTANT.

### MADE-TO-LAST SURFACES RANGING FROM PRECIOUS MATT TO SHINY LIKE A DIAMOND.

GROHE faucets are made to look as beautiful decades on as they did the day you first fell in love with them. The special recipe to success lies in our long-lasting surface quality. GROHE uses state-of-the-art technology to deliver exceptional quality finishes. The physical vapour deposition (PVD) process ensures that the surface composition is three-times harder, delivering glistening gold or sophisticated stainless-steel finishes. As well as being harder, the surface is also ten times more scratch resistant, so it can be cherished for a lifetime.

### NEW COLOURS\*

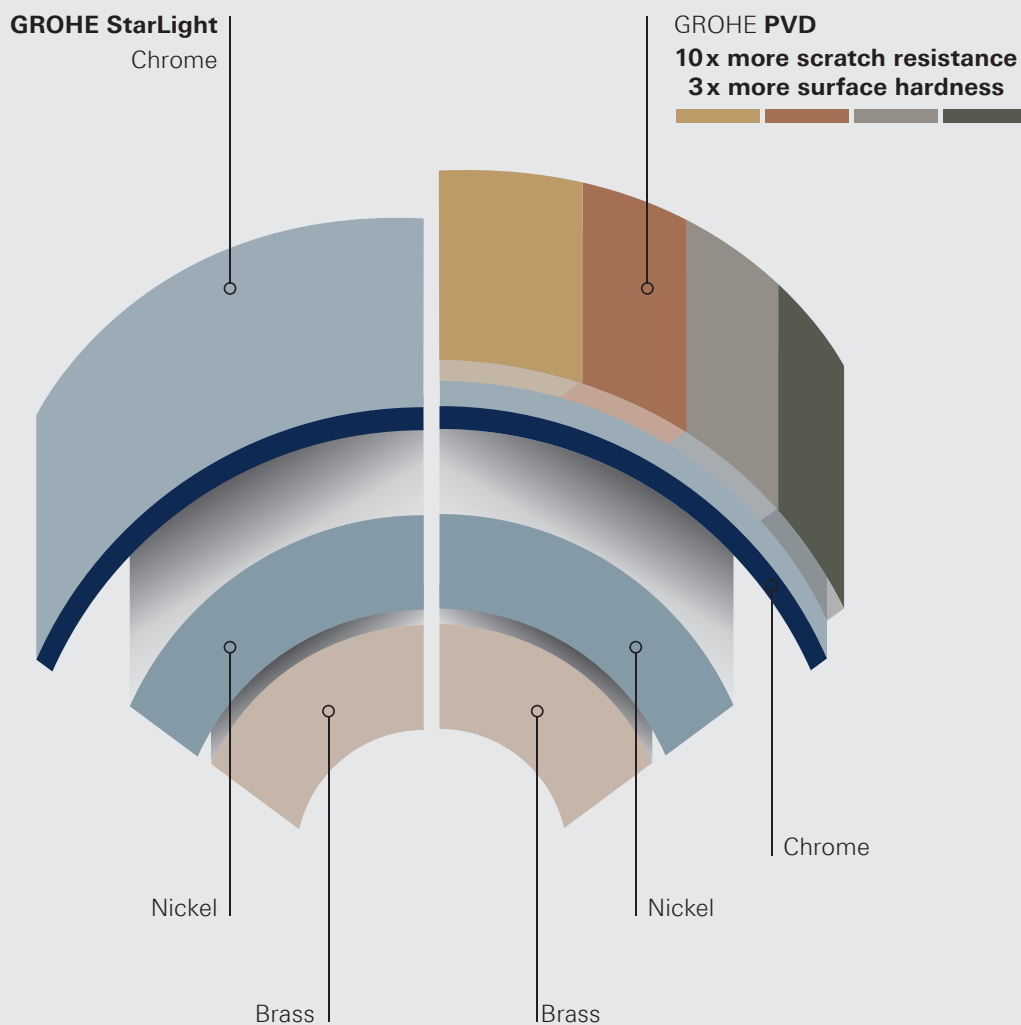
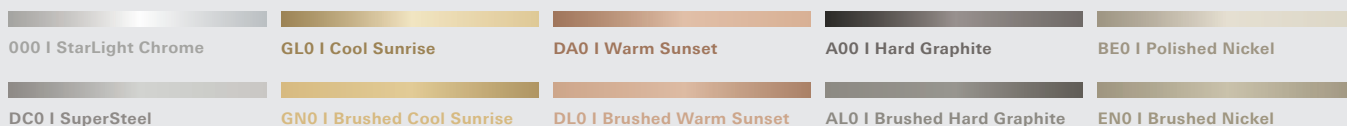

\*available from May 2017



## GROHE **PREWINDOW**

Having your sink area in front of a window provides you with a view to soothe and inspire you while preparing food or washing dishes. With the GROHE PreWindow solution you can open and clean your window easily. Just lift up the tap and lay it flat on the surface - job done.

Available on following lines:  
Eurodisc Cosmopolitan, Concetto, Eurostyle Cosmopolitan,  
Eurosmart Cosmopolitan



## GROHE OPENWATERHEATER

In kitchens that are a long way from the central hot water supply, small boilers directly under the sink are really common. In these specific cases a special kitchen mixer is required. Hot water can run immediately and this solution offers you the perfect flow in combination with open water heaters.

Available on following lines:

Zedra, Minta, Europlus, Eurodisc Cosmopolitan, Concetto, Eurostyle Cosmopolitan, Eurosmart Cosmopolitan







# GROHE ZERO (Lead+Nickel FREE)

No contact of water with lead and nickel due to isolated inner water ways.

Available on following lines:  
Eurosmart, Eurodisc Cosmopolitan, Europlus  
Concetto, Essence New



## GROHE COOLTOUCH

No scalding on hot surfaces thanks to 100% GROHE CoolTouch.

Available on following lines:  
GROHE Red, GROHE Blue, Essence, Concetto, Eurosmart



## GROHE **StopValve**

This small shut-off at the base of your kitchen-mixer turns off the water supply for the dishwasher or washing machine for maximum convenience day-to-day. One quick turn and the water is safely shut-off.

Available on following lines:  
Zedra, Eurodisc Cosmopolitan, Concetto, Eurostyle  
Cosmopolitan, Eurosmart Cosmopolitan, Eurosmart



GROHE BRAND	4
KITCHEN FEATURES	11
› <b>GROHE WATER SYSTEMS</b>	<b>33</b>
GROHE BLUE	38
GROHE BLUE HOME	42
GROHE BLUE PROFESSIONAL	54
GROHE BLUE PURE	58
GROHE BLUE ACCESSORIES	62
GROHE RED	68
GROHE PREMIUM LIFESTYLE COLLECTIONS	81
GROHE PERFORMANCE LINES	137
GROHE SOAP DISPENSERS	176



# WATER SYSTEMS

Water is the source of life, fresh, free-flowing and essential. Our range of water systems offers a tailored drinking experience of purity and convenience that will turn water into a source of health and enjoyment in your home.







# 01

GROHE  
**BLUE**

**Page 38**





02

GROHE  
**RED**

**Page 68**

# GROHE **BLUE**

Enjoy the benefits of fresh filtered water wherever you are. In the comprehensive GROHE Blue range you'll find models designed for every situation - get filtered, still or sparkling water on tap in your own kitchen or select a model ideal for office and professional use. Just need filtered water in your kitchen? Then our entry-level tap is the perfect choice. All versions of GROHE Blue come with the same sleek modern design values, intuitive operation and convenience built in.



# 01

## GROHE BLUE **HOME**

The superior solution for your private home.

PAGE 42



# 02

## GROHE BLUE **PROFESSIONAL**

The excellence for offices & small/medium enterprises.

PAGE 54



# 03

## GROHE BLUE **PURE**

The perfect choice for the entry level.  
Just perfectly filtered water.

PAGE 58









# GROHE BLUE HOME

## YOUR PRIVATE WATER SOURCE

### CHILLED AND SPARKLING

Do you like your chilled drinking water still or sparkling? Somewhere in between? With GROHE Blue the choice is all yours. First the water is filtered to remove impurities. Then it is chilled to create that mountain-fresh taste. And when you turn on the tap a simple twist of the handle lets you choose whether still, medium sparkling or sparkling water flows into your glass.

Fresh water tailored to your exact taste, flowing straight from the faucet – it's as easy as 1, 2, 3. While the right-hand lever on a GROHE Blue faucet mixes hot and cold water as normal, a handle on the left serves the chilled and filtered water and controls how sparkling your drinking water is, from perfectly still to bursting with bubbles.

An LED indicator in the lever changes colour to let you see your chosen carbonation level at a glance – still, medium sparkling or sparkling – as well as telling you when the filter capacity has fallen below 10% and will soon need to be changed. The water temperature can also be set to your personal taste, individually regulated to between 6°C and 10°C.

### VISIT US ONLINE

[KITCHEN >](#)

BLUE HOME







**FIND OUT THE WAYS IN WHICH GROHE BLUE BRINGS BENEFITS TO YOUR HOME:**

Imagine drinking water fresh from a mountain spring – life-affirming, thirst-quenching, and absolutely pure. Now imagine the same health-giving, untainted water flowing directly from your own kitchen faucet. The GROHE Blue water system makes this a reality in your own home. It transforms ordinary tap water and filters it, leaving a taste as fresh and pure as nature intended.

Whatever your idea of perfect water refreshment – filtered, chilled, sparkling or all three – GROHE Blue brings it to you straight from the faucet.



Separated inner water ways for unfiltered tap and filtered drinking water.

## TASTE

GROHE's filters remove impurities to give water a pure, fresh taste that even beats bottled water

## HEALTH & WELLNESS

removing even small particles but leaving behind precious minerals, GROHE Blue makes it easy to embrace the health-giving properties of water

## CONVENIENCE

no more carrying heavy bottled water home

## SUSTAINABILITY

kinder to the environment, with less waste on packaging and processing compared to bottled water



Spout, turnable by 150°

Hygienic mousseur with two outlets

Forward rotating lever with knurled structure for better grip

Cartridge with SilkMove technology for normal tap water



**STILL, MEDIUM OR SPARKLING:  
THE CHOICE IS ALL YOURS**

How sparkling do you like your water? It's all a matter of taste. GROHE Blue Home has a simple and intuitive mechanism that lets you carbonate your drinking water at the touch of a button. Deliciously cool filtered water, just the way that you – and all your family – like it.



Still waters run deep. If you prefer your water cool and still, nothing could be simpler: just push the top button. The LED lights up blue and your glass fills with pure refreshment.



Sparkling – but not too much? More of a medium sparkling? Coming right up. Press both buttons in sequence – the LED lights up turquoise – to produce a finely pearled stream of water.

Sparkling water, alive with bubbles. If that's your idea of thirst-quenching heaven, just press the lower button – the LED lights up green – for your perfect glass of water.

### **HEALTHIER LIVING FROM THE SOURCE**

Water is the most precious and fascinating element on earth, the source of life itself, with proven benefits for our health, wellbeing and even appearance. The „Deutsche Gesellschaft für Ernährung“ (German Nutrition Society) recommends that we drink at least two litres of water each day.

Many of us opt to buy bottled water, either because it tastes better than tap or because we believe it is healthier than tap water. However scientific analysis has proved that, due to strict regulations and controls on our drinking water supplies, tap water is at least as good as bottled.

Another reason people spend a small fortune on bottled water is the preference for sparkling water. Now GROHE Blue delivers all the benefits of bottled water, straight from the tap. It provides a great taste, plus the option of sparkling water too. This makes GROHE Blue the ultimate solution, not just for good health but for great taste as well.

### **CONVENIENCE ON TAP**

Think for a moment about the energy and hassle it takes to keep a supply of bottled water on hand at home. You have to buy it from the supermarket, then lug it from the car to your house. Once there you have to find space to store it out of sight. And when you've finished it you have to return or recycle the plastic bottles, before starting the whole process again.

By installing a GROHE Blue system in your kitchen you can say goodbye to the hassle and inconvenience of bottled water with no compromises on taste or health. Just turn the tap and enjoy an unrivalled refreshment experience. What could be easier than that?

### **WATER NEEDN'T COST THE EARTH**

It takes an astonishing 7 litres of water to produce a single litre of bottled mineral water. Not to mention the energy used, CO2 emissions created and the 1.5 million tons of plastic packaging used by the industry each year.

At GROHE we are always working to secure the future of water, our most precious natural resource. This is the driving force behind the development of such products as GROHE Blue, which help people manage their water and energy consumption with ease.









## THE MAGIC IS IN THE FILTER

For our GROHE Blue system we have worked with BWT, Europe's leading filtered water professionals, to ensure that our system produces an unparalleled, refreshing drinking experience. Our standard high performance S-Size filter comes with every GROHE Blue Home starter set. It uses a five-step filtration process to remove even the smallest particles from tap water, while leaving behind all the important minerals that benefit your health.

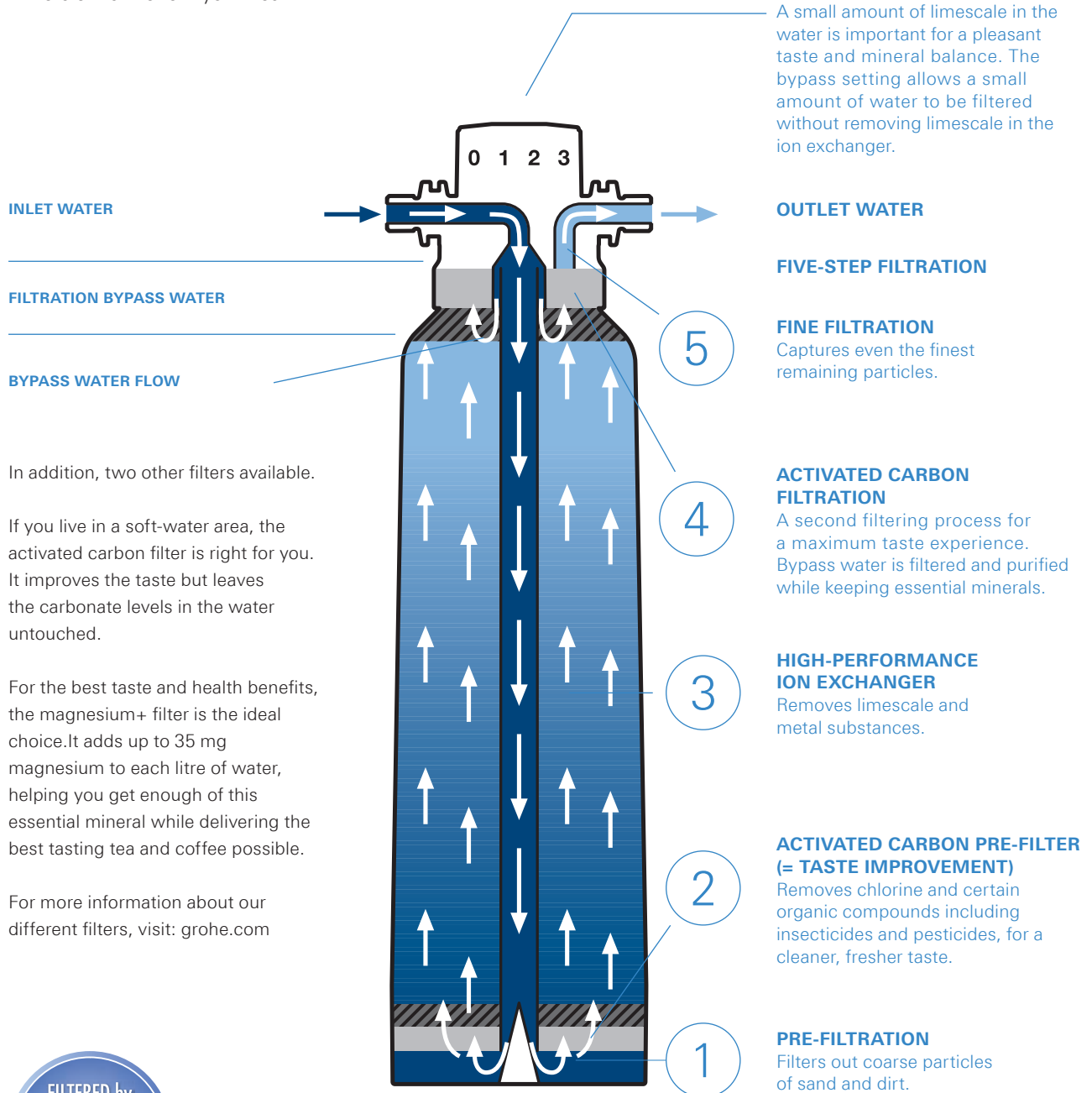

In addition, two other filters available.

If you live in a soft-water area, the activated carbon filter is right for you. It improves the taste but leaves the carbonate levels in the water untouched.

For the best taste and health benefits, the magnesium+ filter is the ideal choice. It adds up to 35 mg magnesium to each litre of water, helping you get enough of this essential mineral while delivering the best tasting tea and coffee possible.

For more information about our different filters, visit: [grohe.com](http://grohe.com)



new

VISIT US ONLINE

[KITCHEN >](#)

[BLUE HOME](#)



**31 454 000 / 31 454 DC0**  
GROHE Blue Home  
L-spout Starter kit



**EACH GROHE BLUE HOME CONTAINS:**



CO2 BOTTLE 425g



S-SIZE FILTER

CARBONATOR  
GROHE BLUE HOME



**31 455 000 / 31 455 DC0**  
GROHE Blue Home  
C-spout Starter kit



**31 456 000 / 31 456 DC0**  
GROHE Blue Home  
U-spout Starter kit



**31 498 000 / 31 498 DC0**  
GROHE Blue Home  
Mono Starter kit

**Colour options:**

● 000 | StarLight Chrome | ● DC0 | SuperSteel



# GROHE BLUE PROFESSIONAL

## THE FRESH SPRING FOR OFFICE KITCHENS

Do you like your chilled drinking water still or sparkling? Somewhere in between? With GROHE Blue the choice is all yours. First the water is filtered to remove impurities. Then it is chilled to create that mountain-fresh taste. And when you turn on the tap a simple twist of the handle lets you choose whether still, medium sparkling or sparkling water flows into your glass.

Fresh water tailored to your exact taste, flowing straight from the faucet – it's as easy as 1, 2, 3. While the right-hand lever on a GROHE Blue faucet mixes hot and cold water as normal, a

handle on the left serves the chilled and filtered water and controls how sparkling your drinking water is, from perfectly still to bursting with bubbles.

An LED indicator in the lever changes colour to let you see your chosen carbonation level at a glance – still, medium sparkling or sparkling – as well as telling you when the filter capacity has fallen below 10% and will soon need to be changed. The water temperature can also be set to your personal taste, individually regulated to between 6 °C and 10 °C.



Still waters run deep. If you prefer your water cool and still, nothing could be simpler.



More of a medium sparkling? Coming right up.



Sparkling water, alive with bubbles.



**31 323 DC1**

GROHE Blue Professional Starter Kit comprises: Single-lever mixer with filter function, water filter complete with filter head, cooler and carbonator box





**VISIT US ONLINE**

[KITCHEN >](#)





**31 323 001 / 31 323 DC1**

GROHE Blue Professional  
Starter Kit comprises: Single-lever  
mixer with filter function, water filter  
complete with filter head, cooler and  
carbonator box





**31 324 001 / 31 324 DC1**

GROHE Blue Professional  
 Starter Kit comprises: Single-lever mixer  
 with filter function, water filter complete  
 with filter head, cooler and carbonator box



**31 346 001 / 31 346 DC1**

GROHE Blue K7 Professional  
 Starter Kit comprises: Single-lever mixer  
 with filter function, water filter complete  
 with filter head, cooler and carbonator box



**31 355 001 / 31 355 DC1**

GROHE Blue Professional  
 Starter Kit comprises: Single-lever mixer  
 with filter function, water filter complete  
 with filter head, cooler and carbonator box

**EACH GROHE PROFESSIONAL CONTAINS:**



WATER FILTER COMPLETE WITH  
 FILTER HEAD, COOLER AND  
 CARBONATOR BOX



**31 347 002 / 31 347 DC2**

GROHE Blue MInta Professional  
 Starter Kit comprises: Single-lever mixer with  
 filter function, water filter complete with filter  
 head, cooler and carbonator box with filter  
 head, cooler and carbonator box



**31 302 001 / 31 302 DC1**

GROHE Blue Professional  
 Starter Kit comprises: Single-lever mixer  
 with filter function, water filter complete  
 with filter head, cooler and carbonator box

**Colour options:**

● 001/002 | StarLight Chrome | ◎ DC1/DC2 | SuperSteel



# GROHE BLUE PURE

## THE WATER REFINER

If pure, filtered, unchilled water is your preference then GROHE Blue Pure is your solution. While the right-hand lever on GROHE Blue Pure faucet mixes hot and cold water as normal, a handle on the left serves the filtered water. Simply select your faucet style from four options - a C- or U-shaped spout, the GROHE Blue K7 with optional pull-out spray or the GROHE Blue Minta, or add an elegant GROHE Blue Mono pillar tap to sit alongside your existing faucet – the choice is all yours.

**VISIT US ONLINE**

[KITCHEN >](#)

BLUE PURE







**33 249 001**  
GROHE Blue Pure  
Starter Kit comprises:  
Single-lever mixer with filter  
function and water complete  
filter with filter head



**31 345 002 / 31 345 DC2**

GROHE Blue Minta new Pure  
Starter Kit comprises: Single-lever mixer  
with filter function, and water filter  
complete with filter head



**33 249 001 / 33 249 DC1**

GROHE Blue Pure Starter Kit  
comprises: Single-lever mixer with filter  
function, and water filter complete with  
filter head



**31 299 001 / 31 299 DC1**

GROHE Blue Pure Starter Kit  
comprises: Single-lever mixer with filter  
function, and water filter complete with  
filter head

**EACH GROHE BLUE PURE CONTAINS:**



**31 354 001 / 31 354 DC1**

GROHE Blue K7 Pure

Starter Kit comprises: Single-lever mixer with side spray and filter function, glass carafe and water filter, complete with filter head



**31 344 001 / 31 344 DC1**

GROHE Blue K7 Pure

Starter Kit comprises: Single-lever mixer with filter function, and water filter complete with filter head



**31 301 001 / 31 301 DC1**

GROHE Blue Mono Pure

Starter Kit comprises: Single-lever mixer with filter function, and water filter complete with filter head

**Colour options:**

● 001/002 | StarLight Chrome | ● DC1/DC2 | SuperSteel



# GROHE BLUE **ACCESSORIES**

Make the most of having delicious chilled, filtered water on tap with our range of GROHE Blue Accessories. From replacement filters for all GROHE Blue faucets, to CO2 cartridges for GROHE Blue chilled and sparkling, plus our own range of branded GROHE water glasses and carafe, you'll find all you need to enjoy your seamless supply of cool, fresh drinking water in your home.

**VISIT US ONLINE**

[KITCHEN >](#)

[BLUE ACCESSORIES](#)







GROHE

GROHE  
BLUE

GROHE  
BLUE



**40 405 000**  
GROHE Blue Glass carafe



**40 437 000**  
GROHE Blue  
Glass 6 pieces



**40 848 000 / 40 848 SD0**  
GROHE Blue drinking bottle tritan (BPA free)  
GROHE Blue drinking bottle stainless steel  
500ml





**40 423 000**  
GROHE Blue CO2  
Starter Kit 2kg bottle

**40 424 000**  
GROHE Blue CO2  
Refill Kit 2kg bottle



**40 422 000**  
GROHE Blue CO2 Starter Kit  
bottle 425g 4 pieces

Available as:  
40 687 000  
GROHE Blue CO2 Refill Kit  
bottle 425g 4 pieces



**40 434 001**  
GROHE Blue  
cleaning cartridge

**40 694 000**  
adapter for GROHE Blue  
BWT filter head only to be used in  
combination with 40 434 001



**40 404 001**  
GROHE Blue  
S-Size Filter  
Capacity 600l at 15° KH

**40 412 001**  
GROHE Blue  
M-Size Filter  
Capacity 1500l at 15° KH

**40 430 001**  
GROHE Blue  
L-Size Filter  
Capacity 3000l at 15° KH

**40 547 001**  
GROHE Blue  
Activated Carbon filter  
For regions with water  
hardness <9° KH  
Capacity 3000l

**40 691 001**  
GROHE Blue Magnesium+  
filter with magnesium  
and premium taste  
capacity 400l at 15° KH









**new**

# GROHE RED

## THE NEW HOT SPOT IN YOUR KITCHEN

Never wait for the kettle to boil again. With the innovative GROHE Red system you can fill anything, from a mug to a large pot, with kettle-hot water in an instant – and all direct from your kitchen faucet. With GROHE Red you still have your standard kitchen mixer, but separate push buttons provide kettle-hot water on tap.

**VISIT US ONLINE**

[KITCHEN >](#)



# TECHNOLOGY YOU CAN TRUST

## STREAMLINE YOUR KITCHEN

Never wait for the kettle to boil again. With the innovative GROHE Red system you can fill anything, from a mug to a large pot, with kettle-hot water in an instant – and all direct from your kitchen faucet. With GROHE Red you still have your standard kitchen mixer, but a push buttons provides kettle-hot water on tap.

Forward rotating lever with knurled structure for better grip

Touch buttons with ChildLock safety for boiling water

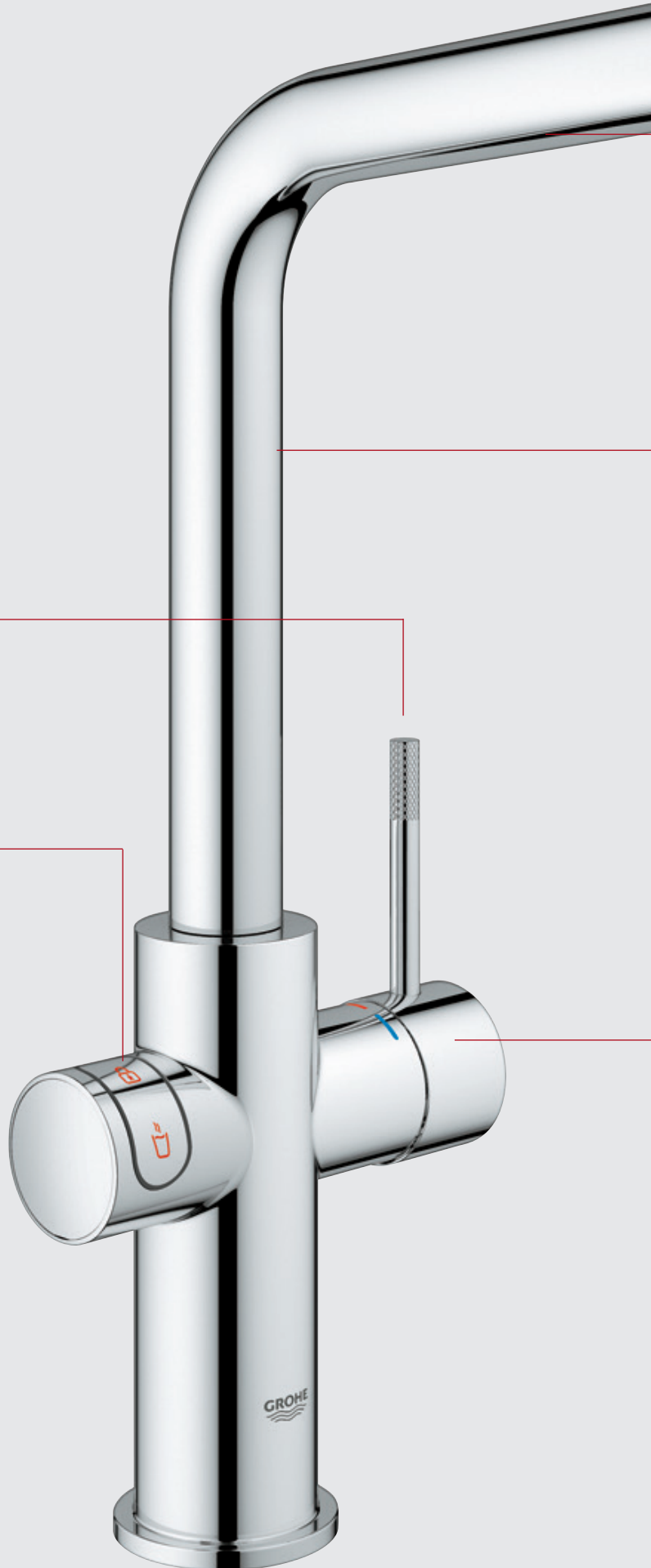





Spout, turnable  
by 150°

Separated inner water  
ways for normal tap and  
boiling water

Cartridge with SilkMove technology  
for normal tap water

## CLEAN, FRESH TASTE

Filtered water heated to 100°C for an  
exceptional taste experience

## LESS WASTE

You only take the exact amount of hot water  
you need, so you save on water and energy  
consumption

## NO MORE WAITING

Kettle-hot water is always available at  
the push of a button, so waiting for the kettle  
or pot to boil is a thing of the past

## CLEAN YOUR WORKTOP

Filtered water heated to 100°C no need for  
the clutter of a kettle. GROHE Red fulfils all  
your water needs from a single faucet

## A SINGLE SIMPLE SOLUTION

### TASTE THE DIFFERENCE

Use GROHE Red in combination with a GROHE Blue filter and get fresh just-filtered water served kettle-hot. Enjoy your tea and coffee with a great clean taste. The boiler where the water is heated is made of titanium, which does not impart any metallic taste to the water. It is also highly resistant to corrosion and limescale build-up, meaning a consistently great taste over the lifetime of the faucet.

### DECLUTTER YOUR KITCHEN

What busy kitchen doesn't need more worktop space? With GROHE Red you can clear the clutter of your kettle from the worktop and get both hot and cold mixed water plus kettle-hot water, all from the same faucet. The system's compact boiler is designed to fit discreetly below the sink, leaving you more counter space and a cleaner, clearer-looking kitchen.

### SAVE PRECIOUS TIME

Never wait for a pot of boiling water or a much-needed cup of tea again. We all lead busy lives, and time spent waiting for water to boil all adds to the time spent on chores rather than relaxing. Whether it's cooking pasta, blanching vegetables or preparing a baby's bottle, GROHE Red cuts out the waiting time with kettle-hot water ready for you, the instant that you want it.

### SAVE WATER, SAVE ENERGY

Think for a moment about how often you boil and reboil the kettle. How often do you actually use all the water? With GROHE Red you only take the hot water you need, saving precious water and time. In combination with the large GROHE Red boiler, which can replace a warm water outlet in the kitchen, the system saves even more water. The large GROHE Red boiler delivers the heated water for both kettle-hot water and also warm water for the sink mixer, instantly. No more wasted water while you wait for it to reach optimum temperature.

### KETTLE-HOT WATER ON TAP

How many times a day do you fill and boil the kettle? From the first cup of tea in the morning to a late night pasta dinner, we boil up water countless times, often heating far more than we need. With GROHE Red you have water heated to 100°C ready when you want it. It's convenient and saves water and time.











# TECHNOLOGY YOU CAN TRUST

Cooking, cleaning, sterilising... not to mention those refreshing cups of tea and coffee. There are so many things we use kettle-hot water for every day of our lives, why wouldn't we want it to be as quick, easy and economic as possible. The GROHE Red system lets you enjoy the convenience of kettle-hot water instantly, without the clutter of a kettle and with many additional benefits too. Enjoy a cleaner taste that is more economical than a kettle and wastes less energy too, all on tap, any time. GROHE Red lets you streamline your kitchen, with three great designs to choose from and the convenience of having all your kitchen water demands met in one sleek faucet.



## GROHE COOLTOUCH

GROHE CoolTouch technology offers you total peace of mind. It insulates the faucet so well that you can touch the spout without any risk of scalding, making it far preferable to a kettle in homes with young children.



## CHILDLOCK

Safety is paramount in a family kitchen. That's why GROHE Red faucets are designed with a child lock that makes scalding practically impossible: for the boiling water to flow, you must first unlock with the upper push button before the lower push button can be used.



## GROHE RED TITANIUM BOILER

All boilers in our GROHE Red collection are made from titanium. Unlike stainless steel and copper, two metals traditionally used for boilers, titanium is highly resistant to corrosion and limescale build-up – ensuring perfect performance over a lifetime. It also guarantees that your water is free of any metallic taste.

# GROHE RED

**GROHE Red boilers\*** are cost and energy efficient – their improved design and insulation mean they achieve an A rating for their efficiency.

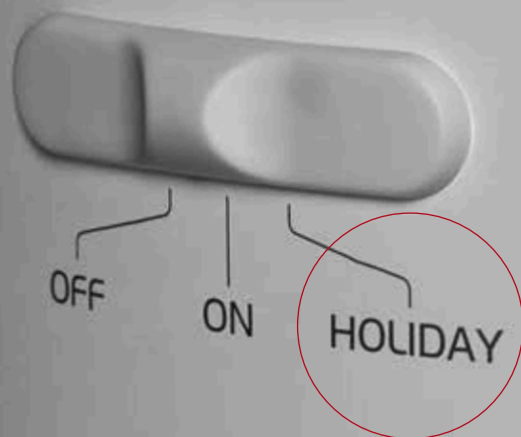

Going on holiday? Then simply switch the boiler to holiday mode, making sure any water is only heated to 60°C for further energy savings.

\* GROHE Red Boiler M size:  
Energy efficiency class A, heat losses max. 14 Wh  
GROHE Red Boiler L size:  
Energy efficiency class A, heat losses max. 15,9 Wh

**L size boiler** for 5.5l  
of boiling water at once

**M size boiler** for 3l  
of boiling water at once



What is more, the titanium used to make the water tank means an incredibly durable boiler that won't corrode.

new

VISIT US ONLINE

[KITCHEN >](#)

**30 325 001 / 30 325 DC0**  
GROHE RED Duo  
L-spout, L Size

**30 327 001 / 30 327 DC0**  
GROHE RED Duo  
L-spout, M Size



**30 079 001 / 30 079 DC0**  
GROHE RED Duo  
C-spout, L Size

**30 083 001 / 30 083 DC0**  
GROHE RED Duo  
C-spout, M Size



**30 080 001 / 30 080 DC0**  
GROHE RED Mono  
C-spout, L Size

**30 085 001 / 30 085 DC0**  
GROHE RED Mono  
C-spout, M Size



**EACH GROHE RED CONTAINS  
BOILER (M OR L SIZE) & FILTERSET.**



**BOILER L SIZE**

**BOILER M SIZE**



**Colour options:**

● 000 | StarLight Chrome | ● DC0 | SuperSteel



GROHE BRAND	4
KITCHEN FEATURES	11
GROHE WATER SYSTEMS	33
› <b>GROHE PREMIUM LIFESTYLE COLLECTIONS</b>	<b>81</b>
GROHE K7	82
GROHE K7 FOOTCONTROL	90
GROHE MINTA	92
GROHE MINTA TOUCH	98
GROHE ZEDRA	102
GROHE ZEDRA TOUCH	108
GROHE ESSENCE	110
GROHE ESSENCE FOOTCONTROL	118
GROHE ESSENCE PROFESSIONAL	120
GROHE EUROCUBE	124
GROHE K4	128
GROHE AMBI	130
GROHE PARKFIELD	132
GROHE PERFORMANCE LINES	137
GROHE SOAP DISPENSERS	176

# GROHE PREMIUM LIFESTYLE COLLECTIONS

At GROHE we understand that your kitchen is a reflection of you. It's more than just a space to cook and clean – it's where you express yourself, enjoy yourself and even stretch yourself. That's why we have created a range of products that allow your inner home chef to shine, with professional-grade functionality that won't let you down, tailored features to help you perform better and intelligent design that reflects your personal taste. With GROHE Premium Lifestyle Collections your kitchen can be as individual as you are.







# GROHE K7

Sleek and striking, the K7 range offers a professional-style kitchen faucet in two spout heights, featuring a 360° turnable spring arm for maximum flexibility and a solid metal spray which allows for easy switching between mousseur and spray function. The K7 range also offers a swivel spout and variants with extractable dual spray and side sprays which guarantee the highest performance levels as well as stunning design. The K7 collection offers the ultimate flexibility for kitchens where performance really matters.

**VISIT US ONLINE**

[KITCHEN >](#)





**32 950 000**  
Professional sink mixer









**32 176 000**  
Sink mixer  
with pull-out dual spray

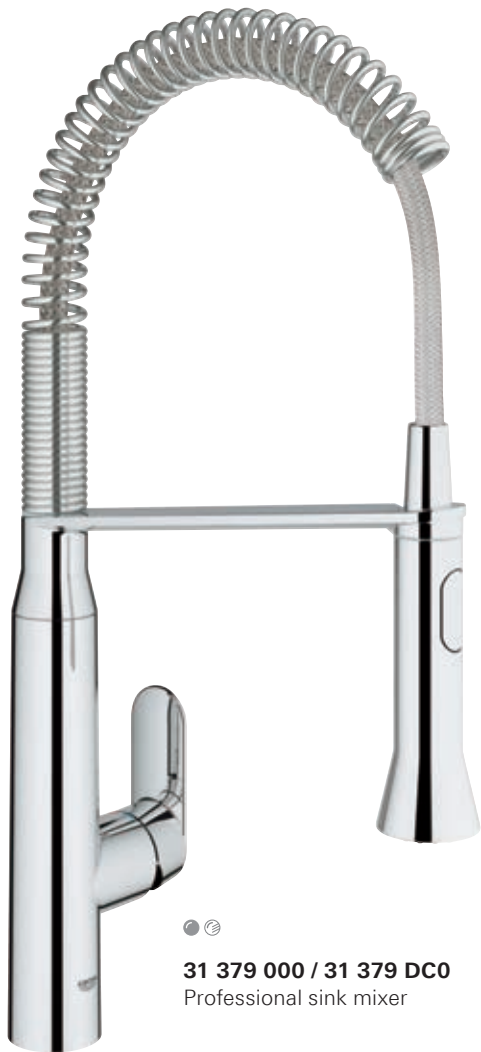

**31 379 000 / 31 379 DC0**  
Professional sink mixer



**32 950 000 / 32 950 DC0**  
Professional sink mixer

**VISIT US ONLINE**

[KITCHEN >](#)





**32 175 000 / 32 175 DC0**  
Sink mixer

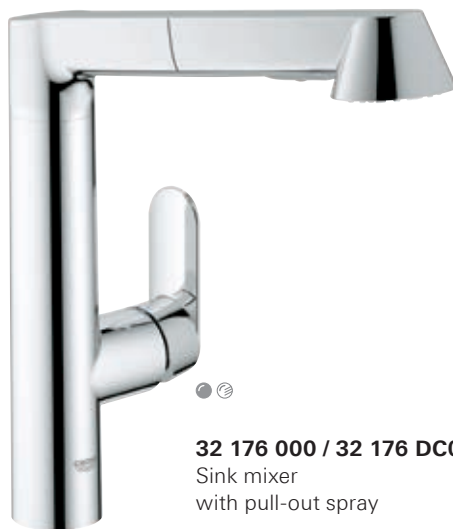

**32 176 000 / 32 176 DC0**  
Sink mixer  
with pull-out spray

**Colour options:**

● 000 | StarLight Chrome | ◉ DC0 | SuperSteel



**new**

# GROHE K7 FOOTCONTROL

Unlock the professional potential of your kitchen with the K7 FootControl faucet. Enjoy the high-performance of the K7's professional spray with the convenience of the FootControl technology. The faucet's crisp architectural styling makes it a design feature in itself, but the exceptional pro-level features mean it's more than a match for any task. For busy kitchens where efficiency is a must the K7 FootControl faucet puts you in total control – and leaves your hands free for other tasks.



**30 312 000 / 30 312 DC0**

Electronic sink mixer  
with professional spray

**Colour options:**

● 000 | StarLight Chrome | ● DC0 | SuperSteel







# GROHE MINTA

A stylish, minimal kitchen doesn't mean compromising on performance. The first thing you'll notice about GROHE's Minta faucet is its sleek, clean silhouette, perfect for a contemporary kitchen. But what you'll enjoy day after day is its fantastic flexibility. With a pull-out spray head with dual spray control it makes cleaning, rinsing and prepping easy, letting you get the most out of your kitchen.



**32 168 000 / 32 168 DC0**  
Sink mixer L-spout  
with pull-out mousseur  
**31 397 000**  
for open water heater

**Colour options:**

● 000 | StarLight Chrome | ☉ DC0 | SuperSteel





**30 274 000 / 30 274 DC0**

Sink mixer L-spout  
with pull-out dual spray



**32 488 000 / 32 488 DC0**  
Sink mixer U-spout



**32 067 000 / 32 067 DC0**  
Sink mixer U-spout  
with pull-out mousseur

**32 322 000 / 32 322 DC0**  
Sink mixer U-spout  
with pull-out mousseur spray

**Colour options:**

● 000 | StarLight Chrome | ◎ DC0 | SuperSteel







**31 375 000 / 31 375 DC0**  
Sink mixer L-spout





**32 918 000 / 32 918 DC0**

Sink mixer C-spout  
with pull-out mousseur

**32 918 00E**

with GROHE EcoJoy

**32 321 000 / 32 321 DC0**

Sink mixer C-spout  
with pull-out mousseur spray

**VISIT US ONLINE**

[KITCHEN >](#)

MINTA



**Colour options:**

● 000/00E | StarLight Chrome | ● DC0 | SuperSteel | ○ LS0 | MoonWhite | ● KS0 | Velvet Black





**32 917 000 / 32 917 DC0**  
**32 917 LSO / 32 917 KSO**  
Sink mixer C-spout

**32 511 000**  
for open water heater

new

# GROHE MINTA TOUCH

Modern and minimal, the sensual curves and arcs of GROHE's Minta range will never go out of fashion, and sit perfectly in any contemporary kitchen. now you can add the ultimate in cleanliness and convenience with the EasyTouch model. Letting you turn the water flow on and off with a touch of your arm, Minta Touch puts you in control.

**VISIT US ONLINE**

[KITCHEN >](#)

MINTA TOUCH







**31 358 000**  
Electronic Sink Mixer  
C-spout, with pull-out  
mousseur spray

# GROHE MINTA TOUCH



**31 358 001 / 31 358 DC1**  
Electronic Sink Mixer C-spout  
with pull-out mousseur spray



**31 360 001 / 31 360 DC1**  
Electronic Sink Mixer L-spout  
with pull-out mousseur



*Minta Touch has been approved and recommended for use by disabled people and the elderly. It has been tested and rated "good" by the Institute for Gerontotechnik for Barrier Free Building, due to its one-touch operating technology and ergonomic design.*

**Colour options:**

● 001 | StarLight Chrome | ● DC1 | SuperSteel



# GROHE **ZEDRA**

GROHE's Zedra features a dual-control button with locking feature, which lets you switch effortlessly between spray modes and a SpeedClean nozzle makes removing limescale a breeze. Choose between a high-gloss GROHE StarLight (chrome finish), a matte SuperSteel finish or the anti-bacterial properties of RealSteel for a faucet that is as durable as it is beautiful.

**VISIT US ONLINE**

[KITCHEN >](#)

ZEDRA 





**32 294 SD1**  
Sink mixer  
with pull-out dual spray







**32 294 001**  
Sink mixer  
with pull-out dual spray





**32 296 000 / 32 296 SD0**  
Sink mixer  
with pull-out mousseur spray



**32 553 000 / 32 553 SD0**  
Sink mixer with pull-out dual spray  
**32 555 000**  
for open water heater

**VISIT US ONLINE**

[KITCHEN >](#)

ZEDRA







● **31 203 000**

Sink mixer with pull-out mousseur spray and shut-off valve



● ●

**30 026 000 / 30 026 SD0**

Pillar tap

**Colour options:**

● 000 | StarLight Chrome | ● SD0 | Stainless Steel



# GROHE ZEDRA TOUCH

A distinctive, delicate body conceals advanced technology in the new Essence faucet. The cylindrical body is super-slim, thanks to a new small cartridge, offering pure elegance without compromise. A solid metal spray head guarantees life-long performance, and you can switch easily between two spray patterns with a toggle function that puts flexibility to the fore.



**30 219 001 / 30 219 DC1**  
Electronic Sink Mixer  
with pull-out dual spray

**Colour options:**

● 001 | StarLight Chrome | ● DC1 | SuperSteel











# GROHE ESSENCE

Choose between two models, one with swivel spout and one with a solid metal pull-out spray, which offers easy switching between mousseur and spray. Add in a choice of two great-looking and durable finishes and you'll see that great design doesn't have to mean compromise on functionality.

**VISIT US ONLINE**

[KITCHEN >](#)

ESSENCE





**30 270 000**

Sink mixer high spout  
with pull-out dual spray

# DISCOVER THE EXCITING **NEW COLOURS** IN THE ESSENCE RANGE

Inspired by worldwide colour trends emerging at international design shows, GROHE now offers 10 colour finishes, presented for the first time in the complete Essence line. With its extensive range of sizes, colours and finishes, the new Essence series will make you feel completely spoilt for choice. The full range – from faucets to showers and accessories – offers you four different colours to choose from, either with an elegantly brushed or highly polished finish. Also available in SuperSteel and chrome. That's what we call freedom of choice.





WARM SUNSET | **DA0**



HARD GRAPHITE | **A00**

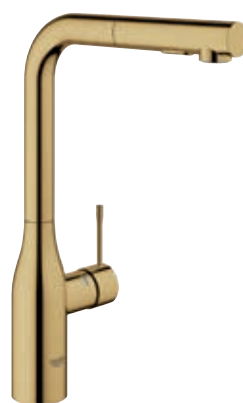

COOL SUNRISE | **GLO**

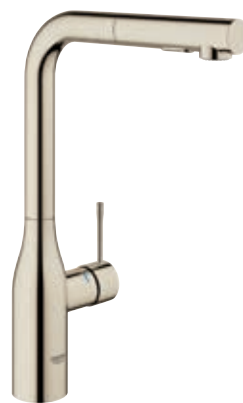

POLISHED NICKEL | **BE0**



SUPERSTEEL | **DCO**



**30 269 000**  
Sink mixer high spout  
with pull-out dual spray





**30 270 000**  
Sink mixer high spout  
with pull-out dual spray

**Colour options:**

● 000 | StarLight Chrome  
● DC0 | SuperSteel

● GL0 | Cool Sunrise  
● GN0 | Brushed Cool Sunrise

● DA0 | Warm Sunset  
● DL0 | Brushed Warm Sunset

● A00 | Hard Graphite  
● AL0 | Brushed Hard Graphite

● BE0 | Polished Nickel  
● EN0 | Brushed Nickel

# GROHE ESSENCE FOOTCONTROL

Introduce the purity of minimalism to your kitchen while enjoying the effortless functionality of hands-free operation with GROHE's Essence FootControl faucet. The sleek, simple lines of our Essence faucet are the perfect complement to a contemporary kitchen, while the one-touch FootControl lets you keep your hands free and your faucet germ-free. With a pull-out dual spray feature and the dazzling, durable GROHE StarLight finish, the Essence FootControl is the perfect choice for a fuss-free kitchen design.



**30 311 000 / 30 311 DC0**  
Electronic Sink Mixer  
L-spout  
with professional spray

**Colour options:**

● 000 | StarLight Chrome | ● DC0 | SuperSteel







# THE COLOURFUL WORLD OF **ESSENCE PROFESSIONAL**

Enhance your kitchen's performance with the sleek, architectural Essence Professional tap, designed to bring professional features and convenience to your scheme. From the 360 degree turnable spring arm to the effortless EasyDock M magnetic system for the dual-spray metal head, every detail has been designed with ease of use in mind. Featuring GrohFlexx technology, the hygienic santoprene hose is not only easy-to-clean but also comes in a choice of 11 colour finishes to harmonise with any kitchen.

**DESIGN PLUS**

powered by: **ISH**





new



● ●  
**30 294 000 / 30 294 DC0**  
Professional sink mixer



Combine your Essence Professional (chrome/supersteel) with a choice of 11 colour finishes to make it the perfect fit for your kitchen.

**Colour options\* (30 321 + Colour code):**

- |               |                      |                   |                |                    |             |
|---------------|----------------------|-------------------|----------------|--------------------|-------------|
| ● K00   Black | ● MW0   Sheer Marble | ● XC0   Dark Grey | ● YF0   Yellow | ● YR0   Orange     | ● DG0   Red |
| ● DP0   Pink  | ● DU0   Purple       | ● GE0   Green     | ● TY0   Blue   | ● HG0   Dark Brown |             |

\*available from May 2017





**Colour options:**

● 000 | StarLight Chrome | ● DC0 | SuperSteel





**31 395 000**  
Professional sink mixer



# GROHE EUROCUBE

Make a statement with GROHE's Cubist masterpiece. The Eurocube's strong lines and solid, architectural shape is perfect for modern kitchens where design is at the forefront. From the lever's cut-out detailing to the new professional-grade features, this is a faucet for those who are both style conscious and serious about their cooking.



**31 255 000 / 31 255 DC0**  
Sink mixer



**31 395 000 / 31 395 DC0**  
Professional sink mixer

**VISIT US ONLINE**

[KITCHEN >](#)

EUROCUBE



**Colour options:**

● 000 | StarLight Chrome | ● DC0 | SuperSteel







**31 255 000**  
Sink mixer

# GROHE K4

Enjoy a kitchen experience that is dramatically different. The K4 not only looks unlike any other faucet, it also offers specialist performance in the heart of your home. The dramatic arcing exterior conceals a 360° swivel spout and pull-out spray that gives you total freedom and convenience.



**33 782 000**  
Sink mixer  
with pull-out dual spray



**33 786 000**  
Sink mixer  
with pull-out mousseur





# GROHE **AMBI**

Opt for a contemporary classic with the Ambi faucet range. Advanced engineering meets subtle design options in Ambi's two models, both with the comfortable functionality of twin forward-rotating levers.



**30 189 000**  
Contemporary  
2 handle sink mixer



**30 190 000**  
Cosmopolitan  
2 handle sink mixer







# GROHE PARKFIELD

Simple, streamlined and modern – GROHE’s Europlus has a universal appeal. A sculpted body flows seamlessly into a smooth lever handle, tilted at a 7 degree angle for easy handling and optimal ergonomics. Choose from a low or medium-height spout model, and add a pull-out dual spray for even greater flexibility.



**30 215 000 / 30 215 DC0**  
Sink mixer  
with pull-out dual spray

## VISIT US ONLINE

[KITCHEN >](#)



### Colour options:

● 000 | StarLight Chrome | ● DC0 | SuperSteel













GROHE BRAND	4
KITCHEN FEATURES	11
GROHE WATER SYSTEMS	33
GROHE PREMIUM LIFESTYLE COLLECTIONS	81
› <b>GROHE PERFORMANCE LINES</b>	<b>137</b>
GROHE EUROPLUS	138
GROHE EURODISC COSMOPOLITAN	142
GROHE EURODISC	148
GROHE CONCETTO	152
GROHE EUROSTYLE COSMOPOLITAN	158
GROHE EUROSMART COSMOPOLITAN	162
GROHE EUROSMART	166
GROHE BAULOOP & BAUEDGE	172
GROHE COSTA S / COSTA L	174
GROHE SOAP DISPENSERS	176

# GROHE PERFORMANCE LINES

Get the most out of your busy kitchen with GROHE's Performance Lines. Created to offer a huge range of practical features to make any kitchen easier, safer and more enjoyable to use, you'll bound to find the perfect solution. With a variety of modern designs, plus versatile height and installation options, GROHE Performance Lines offer great value and functionality that will enhance your life every day.

# GROHE **EUROPLUS**

Simple, streamlined and modern – GROHE's Europlus has a universal appeal. A sculpted body flows seamlessly into a smooth lever handle, tilted at a 7 degree angle for easy handling and optimal ergonomics. Choose from a low or medium-height spout model, and add a pull-out dual spray for even greater flexibility.

**VISIT US ONLINE**

[KITCHEN >](#)

EUROPLUS





**33 933 002**  
Sink mixer medium spout  
with pull-out dual spray





**33 930 002**  
Sink mixer medium spout

**33 931 002**  
for open water heater



**33 933 002**  
Sink mixer medium spout  
with pull-out dual spray



**32 941 002**  
Sink mixer low spout



**32 942 002**  
Sink mixer low spout  
with pull-out dual spray







**33 700 002**  
Sink mixer  
with pull-out dual spray







**33 700 002**  
Sink mixer with  
pull-out dual spray

# GROHE EURODISC COSMOPOLITAN

Proving that intensely practical design can work in balance with attractive, modern styling, Eurodisc Cosmopolitan has been created to be the perfect solution for any kitchen setting. You'll love the variety on offer, making for easy installation and even easier use, while a tapering spout and slightly angled lever add to the sleek effect.

## VISIT US ONLINE

[KITCHEN >](#)



### **32 257 002**

Sink mixer medium spout  
with pull-out dual spray

### **31 121 002**

for open water heater





**23 657 000**  
M-Size, Basin mixer  
with pop-up waste set



**32 259 002**  
Sink mixer high spout  
**31 242 002**  
for open water heater



**31 122 002**  
Sink mixer high spout  
with pull-out mousseur  
**32 546 002**  
for open water heater





**33 770 002**  
Sink mixer medium spout

**31 206 002**  
for open water heater



**33 312 002**  
Sink mixer medium spout  
pre-window



**31 237 002**  
Sink mixer medium spout  
with shut-off valve

**31 120 002**  
for open water heater



**33 772 002 + 18 349 L02**  
Sink mixer wall-mounted  
with tray



# GROHE **EURODISC**

Smart design paired with practical features – the Eurodisc delivers on all fronts. A swivel spout makes daily tasks easier, and the fin-shaped lever can be operated using just two fingers, giving you great control with minimal effort. Add an optional pull-out dual spray and you’ve got a great all-round solution for any busy kitchen.

**VISIT US ONLINE**

[KITCHEN >](#)

EURODISC





**32 257 001**  
Sink mixer low spout  
with pull-out dual spray



**32 257 001**  
Sink mixer low spout  
with pull-out dual spray







**33 770 001**  
Sink mixer low spout

**33 771 001**  
Sink mixer low spout



# GROHE CONCETTO

Making distinctive design accessible for all, Concetto is ideal for kitchens where style and practicality have to go hand-in-hand. Design-lovers will adore the distinctive silhouette based on a series of cylinders, while the hard-working cook will appreciate the finger-tip control and great performance.



**31 491 000**  
Professional sink mixer

**VISIT US ONLINE**

[KITCHEN >](#)



**Colour options:**

● 000 | StarLight Chrome | ● DC0 | SuperSteel



**31 491 DCO**  
Professional sink mixer

**SUPER  
STEEL**

GROHE









**30 273 001**  
Sink mixer medium spout  
with pull-out dual spray



**31 128 001 / 31 128 DC1**  
Sink mixer medium spout

**31 213 001**  
for open water heater

**31 210 001**  
for pre-window

**31 211 001**  
for open water heater



**31 129 001 / 31 129 DC1**  
Sink mixer medium spout  
with pull-out mousseur

**31 214 001**  
for open water heater



**30 273 001 / 30 273 DC1**  
Sink mixer medium spout  
with pull-out dual spray



**32 659 001 / 32 659 DC1**  
Sink mixer low spout



**31 483 001 / 31 483 DC1**  
Sink mixer high spout  
with pull-out mousseur spray



**32 661 001 / 32 661 DC1**  
Sink mixer high spout

**31 132 001**  
for open water heater

**32 666 001**  
with shut-off valve



**32 663 001 / 32 663 DC1**  
Sink mixer high spout  
with pull-out mousseur

**31 212 001**  
for open water heater



**32 667 001**  
Sink mixer  
wall-mounted

**Colour options:**

● 001 | StarLight Chrome | ● DC1 | SuperSteel



# GROHE **EUROSTYLE COSMOPOLITAN**

Great design and great performance are at your fingertips with the Eurostyle Cosmopolitan range. From the appealing lozenge-shape of the lever to a choice of dynamic spout shapes, Eurostyle Cosmopolitan has a solution for every type of kitchen environment.

**VISIT US ONLINE**

[KITCHEN >](#)







**31 124 002**  
Sink mixer  
medium spout



**33 975 002**  
Sink mixer high spout

**31 127 002**  
for open water heater



**31 126 002**  
Sink mixer high spout  
with pull-out mousseur



**31 482 002**  
Sink mixer high spout  
with pull-out mousseur spray



**30 221 002**  
Sink mixer high spout



**31 124 002**  
Sink mixer medium spout

**31 154 002**  
for open water heater

**31 159 002**  
for pre-window



**31 153 002**  
Sink mixer medium spout  
with shut-off valve



**33 977 002**  
Sink mixer low spout

**33 984 002**  
for open water heater



**33 982 002 + 18 383 002**  
Sink mixer  
wall-mounted  
with tray



# GROHE

# EUROSMART COSMOPOLITAN

Simplicity is at the heart of good design and functionality. That's why GROHE's Eurosmart Cosmopolitan range focuses on the essentials to create a collection with durable details and architectural edge.

Put ergonomics and architectural lines centre-stage in your kitchen with Eurosmart Cosmopolitan. With this range simplicity doesn't mean lack of choice – from the three height options to the user-friendly swivel spout or an extractable mousseur spray you'll find a solution to suit you and your own contemporary kitchen.

**VISIT US ONLINE**

[KITCHEN >](#)

EUROSMART COSMOPOLITAN 







**31 481 000**

Sink mixer high spout  
with pull-out mousseur spray



**32 843 000 / 32 843 DC0**  
Sink mixer high spout

**32 843 00E**  
with GROHE EcoJoy

**31 180 000**  
for open water heater



**31 481 000**  
Sink mixer high spout  
with pull-out mousseur spray



**30 193 000 / 30 193 DC0**  
Sink mixer medium spout

**30 194 000 / 30 194 DC0**  
for open water heater



**30 195 000**  
Sink mixer medium spout  
with shut-off valve



**32 842 000**  
Sink mixer low spout

**32 842 00E**  
with GROHE EcoJoy

**31 179 000**  
for open water heater

**31 170 000**  
Sink mixer low spout  
pre-window

**31 161 000**  
Sink mixer low spout  
shut-off valve

**Colour options:**

● 000/00E | StarLight Chrome | ◎ DC0 | SuperSteel



# GROHE EUROSMART

Create a kitchen that the whole family can take pleasure in with the new GROHE Eurosmart. Effortless control, unrivalled performance and temperature-safe operation combine in a sleek contemporary design. The solid cylindrical body, the elegant curve of the spout – the new Eurosmart range looks great while offering huge versatility. In a variety of two heights, with a useful swivel spout and the option of our water-saving GROHE EcoJoy feature or the energy-saving cold-start cartridge GROHE SilkMove ES, Eurosmart is bound to fit in with your busy family kitchen.

Take your kitchen to the next level with the new Eurosmart pull-out kitchen faucet. Equipped with the basic features of Eurosmart and adding a functional pull-out dual spray, Eurosmart pull-out will help you do your daily kitchen tasks with just tip of your finger. The pull-out dual spray gives you a greater operating radius of the faucet while offering easy switching between two sprays. The EasyDock mechanism guarantees easy retraction and smooth docking for your spray head, every time. Eurosmart pull-out comes with a shiny chrome surface or a matt SuperSteel finish to fit your kitchen perfectly.

**VISIT US ONLINE**

[KITCHEN >](#)

EUROSMART





**30 305 000**  
Sink mixer low spout  
with pull-out dual spray



Integrated temperature limiter

No scalding on hot surfaces thanks to 100% **GROHE CoolTouch**.

EasyDock

Lead and nickel free

35mm cartridge with integrated temperature limiter

## MODERN SHAPE & SMART TECHNOLOGY

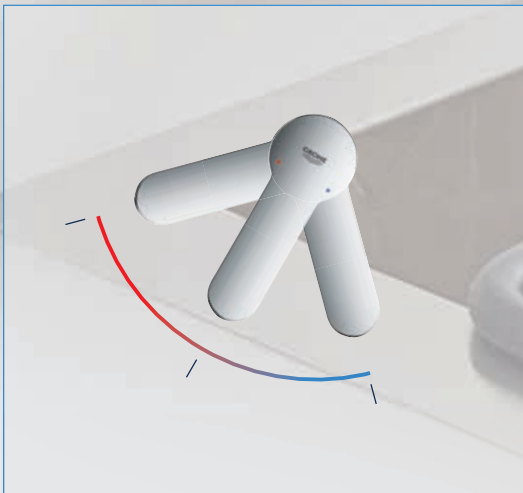

**GROHE cartridge with integrated temperature limiter** Can be individually set to the desired maximum water temperature.



**Pull-out  
dual spray**

**SpeedClean  
mousseur**

**EasyExchange**

The aerator is easy to install  
and de-install using just a coin.





**33 281 002 / 33 281 DC2**

Sink mixer low spout  
lead & nickel free

**33 281 20E**

with GROHE EcoJoy

**30 260 002**

Sink mixer low spout  
lead & nickel free  
with GROHE SilkMove ES



**30 305 000 / 30 305 DC0**

Sink mixer low spout  
with pull-out dual spray



**Also available as a bundle consisting of:**

Sink mixer low spout, Lead & nickel free  
1 angle valve & 1 combined angle valve  
for dishwasher **31 478 000**





**33 202 002 / 33 202 DC2**  
Sink mixer high spout

**33 490 002**  
Sink mixer high spout  
with GROHE SilkMove ES  
with shut-off value



**32 482 002**  
Sink mixer  
wall mounted



**31 509 002**  
Sink mixer  
Wall mounted  
with 150mm projection

**31 509 002**  
with 217mm projection

**32 224 002**  
with 277mm projection

**Colour options:**

● 000/002/20E | StarLight Chrome | ◎ DC0/DC2 | SuperSteel



# GROHE **BAULOOP & BAUEDGE**

Stunning simplicity defines the GROHE Bau. The cylindrical spout creates a lightness of design ideal for architectural schemes without compromising performance. The unique loop-shaped lever of BauLoop and the lozenge-shaped lever of BauEdge simplify handling and are extremely easy to operate.



**31 368 000**  
GROHE BauLoop  
Kitchen sink mixer

**VISIT US ONLINE**

[KITCHEN >](#)

[BAULOOP & BAUEDGE](#)





**31 367 000**  
GROHE BauEdge  
Kitchen sink mixer

# GROHE **COSTA S**

Can you improve on a classic? At GROHE that's just what we've done. The Costa collection was first launched in the 1970s, and we've been refining it ever since. It's design that has stood the test of time, improved and updated with the latest GROHE engineering excellence.



**31 819 001**  
Sink mixer



# GROHE COSTA L

Classic design reinterpreted for today's kitchen – Costa L takes the classic Costa design and adds solid metal handles and long-life parts for a look and function that's designed to be durable.



**31 191 001**  
Sink mixer  
wall-mounted



**31 831 001**  
Sink mixer

**31 930 001**  
for open water heater

**VISIT US ONLINE**

[KITCHEN >](#)

COSTA



# GROHE SOAP DISPENSERS

The perfect way to add the finishing touch to your kitchen is with one of GROHE's range of modern and elegant soap dispensers. Practical and durable, they are built with classic GROHE workmanship and designed to match all of GROHE's kitchen faucets.



**40 535 000 / 40 535 DC0**  
Cosmopolitan soap dispenser  
for liquid soaps  
storage bin 0.4 l



**40 536 000 / 40 536 DC0**  
150mm projection  
Contemporary soap dispenser  
for liquid soaps  
storage bin 0.4 l



**40 537 000 / 40 537 DC0**  
Authentic soap dispenser  
for liquid soaps  
storage bin 0.4 l



**40 553 000 / 40 553 DC0**  
Zedra soap dispenser  
for liquid soaps  
storage bin 0.4 l











**Colour options:**

● 000 | StarLight Chrome | ● DC0 | SuperSteel























## GROHE BLUE & GROHE RED WATER SYSTEMS



















	DESIGN	MIXED WATER	FILTERED WATER	SPARKLING WATER	BOILING WATER	SIDE SPRAY	CO2-BOTTLE 425 G	S-SIZE FILTER	FILTERHEAD	BOILER	CHROME	SUPERSTEEL	STAINLESS STEEL	PVD COLOURS	BEST MATCH	
															SOAP DISPENSER 40 535 000 / 40 535 DC0	SOAP DISPENSER 40 553 000 / 40 553 DC0
GROHE BLUE HOME		●	●	●			●	●	●		●	●			●	
		●														
GROHE BLUE HOME MONO			●	●			●	●	●		●	●			●	
GROHE BLUE PROFESSIONAL		●	●	●			●	●	●		●	●			●	
		●														
GROHE BLUE MONO PROFESSIONAL			●	●			●	●	●		●	●			●	
GROHE BLUE PURE		●	●					●	●		●	●			●	
GROHE BLUE MONO PURE			●					●	●		●	●			●	
GROHE RED DUO		●			●					●	●	●			●	
GROHE RED MONO					●					●	●	●			●	



## GROHE FUNCTIONALITY AT A GLANCE

	DESIGN	EASYTOUCH	FOOTCONTROL	PROFESSIONAL SPRAY	PULL-OUT DUAL SPRAY	PULL-OUT MOUSSEUR SPRAY	PULL-OUT MOUSSEUR	SIDE SPRAY	PRE-WINDOW	SHUT-OFF VALVE	CHROME	SUPERSTEEL	STAINLESS STEEL	PVD COLOURS	BEST MATCH - OUR RECOMMENDATION			
															SOAP DISPENSER 40 535 000 / 40 535 DC0	SOAP DISPENSER 40 536 000 / 40536 DC0	SOAP DISPENSER 40 553 000 / 40 553 DC0	SOAP DISPENSER 40 537 000 / 40 537 DC0
GROHE K7					●			●			●	●			●			
				●							●	●			●			
GROHE K7 FOOTCONTROL			●	●							●	●			●			
GROHE MINTA					●	●	●				●	●			●			
						●	●				●	●			●			
GROHE MINTA TOUCH		●				●					●	●			●			
		●					●				●	●			●			
GROHE ZEDRA					●						●		●				●	
					●	●				●	●		●				●	
GROHE ZEDRA TOUCH		●			●						●	●					●	
GROHE ESSENCE				●	●						●	●		●	●			
GROHE ESSENCE FOOTCONTROL			●		●						●	●			●			
GROHE EUROCUBE											●	●						
				●							●	●						
GROHE K4					●		●				●		●				●	
GROHE AMBI											●				●	●		
GROHE PARKFIELD					●						●	●						●
GROHE EUROPLUS					●						●					●		
					●						●					●		
GROHE EURODISC COSMOPOLITAN					●				●	●	●				●			
							●				●				●			
											●				●			

## GROHE FUNCTIONALITY AT A GLANCE

	DESIGN	EASYTOUCH	FOOTCONTROL	PROFESSIONAL SPRAY	PULL-OUT DUAL SPRAY	PULL-OUT MOUSSEUR SPRAY	PULL-OUT MOUSSEUR	SIDE SPRAY	PRE-WINDOW	SHUT-OFF VALVE	CHROME	SUPERSTEEL	STAINLESS STEEL	PVD COLOURS	BEST MATCH - OUR RECOMMENDATION			
															SOAP DISPENSER 40 535 000 / 40 535 DC0	SOAP DISPENSER 40 536 000 / 40536 DC0	SOAP DISPENSER 40 553 000 / 40 553 DC0	SOAP DISPENSER 40 537 000 / 40 537 DC0
GROHE EURODISC					●						●					●		
											●					●		
GROHE CONCETTO				●							●	●			●			
				●	●		●		●	●	●	●			●			
				●		●	●			●	●	●			●			
GROHE EUROSTYLE COSMOPOLITAN											●				●			
									●	●	●				●			
						●	●				●				●			
											●				●			
GROHE EUROSMART COSMOPOLITAN									●	●	●				●			
										●	●	●			●			
						●					●	●			●			
GROHE EUROSMART					●						●	●				●		
										●	●	●				●		
											●					●		
GROHE BAU										●						●		
GROHE COSTA S											●					●		
GROHE COSTA L											●					●		
											●					●		



# DISCOVER THE WORLD OF GROHE

What you see here represents just a small selection of what the world of GROHE has to offer. Whether you are looking for ideas and inspiration or solutions for bath and kitchen, here's where you'll find it.

Just scan the QR codes to view the latest brochures as download or PDF on your tablet or smartphone. Or visit the world of GROHE at [grohe.com](http://grohe.com)

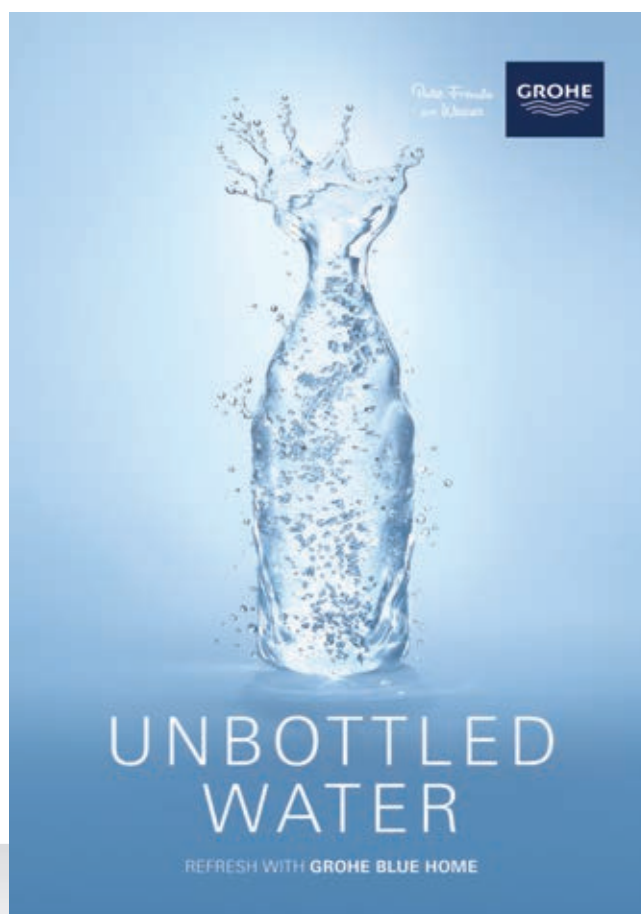

**BLUE HOME BROCHURE**

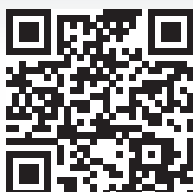





WATER. INTELLIGENCE. ENJOYMENT.  
MAGAZIN

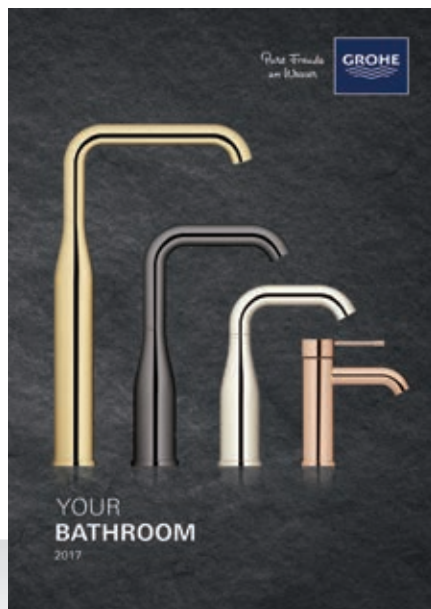

BATH BROCHURE

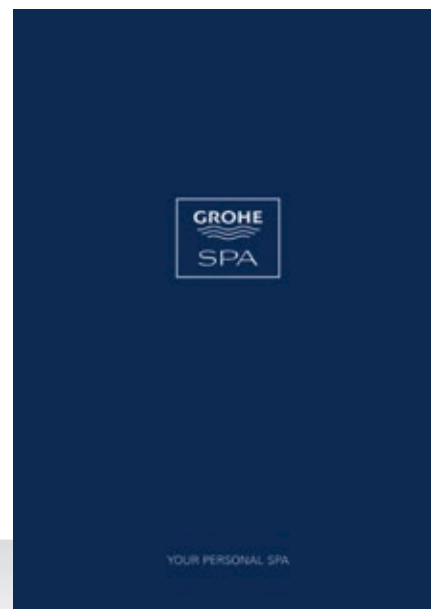
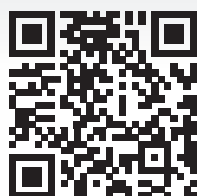

SPA BROCHURE



CERAMICS BROCHURE

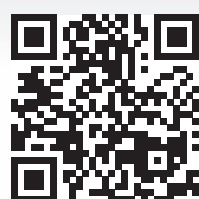

SENSIA ARENA BROCHURE

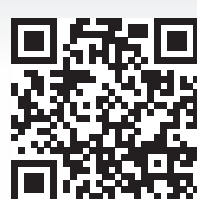

RAPIDO SMARTBOX BROCHURE



# A GLOBALLY CONNECTED COMPANY

## **GROHE IS PART OF LIXIL – A GLOBAL LEADER IN THE HOUSING AND BUILDING INDUSTRY.**

Beginning back in early 20th century Japan, LIXIL is today the most comprehensive company in our industry, with a unique portfolio spanning everything from technologies that revolutionize how we interact with water, to a full lineup of interior and exterior materials and products for houses and major architectural projects. Operating in 150 countries, LIXIL companies design and manufacture products that are used by more than a billion people around the world every day.

**The world is changing rapidly, and LIXIL companies are helping to shape it.** Across our brands and technologies, we design and manufacture tomorrow's living solutions, today. From developing smart innovations in people's homes and offices, to redefining the world's most famous city skylines, LIXIL products are transforming the spaces in which we all work, learn, travel, relax, and live.

**Alongside GROHE in LIXIL's family of world-class brands are American Standard, INAX, DXV by American Standard and Permasteelisa.** Combined, our brands make us number one in faucets and plumbing-related products worldwide and Japan's premier provider of housing products. We're leading the way in many other areas around the world, thanks to our shared focus on creating innovations that genuinely improve people's lives.

**Together we're stronger.** Combining our GROHE expertise as a world leader in sanitary fittings with the unique technology and insights from LIXIL's other Water Technology brands, GROHE now offers complete bathroom solutions, featuring innovative products like shower toilets and SmartControl showers, alongside revolutionary technologies such as AquaCeramic sanitaryware that stays clean for 100 years. Beautiful, functional and reliable, LIXIL's products and solutions are changing the way people live, all over the world.

**Together, we share a powerful vision of a better tomorrow, for our customers and for the world.** As a truly global manufacturing company, we know that we have an important part to play in securing the future of our planet. We're leading the way in areas such as energy efficiency and water saving technology and aim to achieve a net zero environmental footprint by 2030. We believe everyone should have access to clean and safe sanitation, and are committed to using our expertise to help make this possible.

**Together we're creating the future of good living for everyone, everywhere.**



Follow us



Just scan the QR code to view the latest brochure as download or PDF on your tablet or smartphone.

Grohe AG  
Feldmühleplatz 15  
D - 40545 Düsseldorf  
Germany

© 03/2017 – Copyright by GROHE

PART OF **LIXIL**